

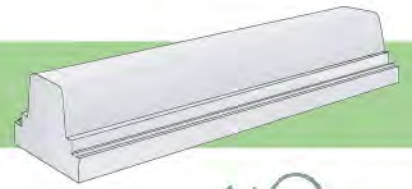

草止

# ベース付歩車道境界ブロック B



AICOLE

## 標準

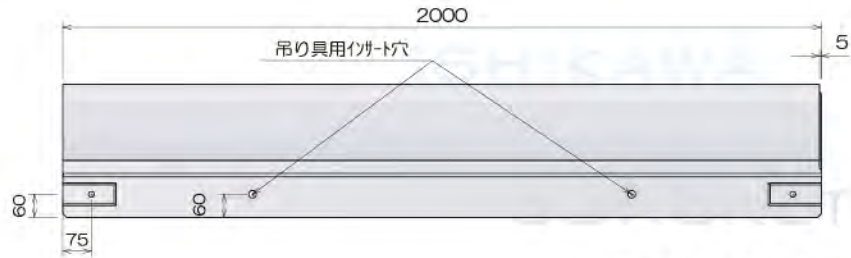
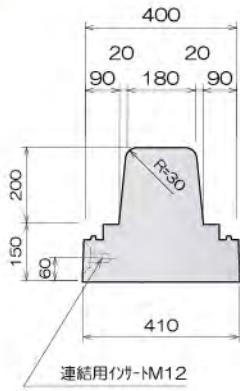

参考重量 470kg

## 水抜き

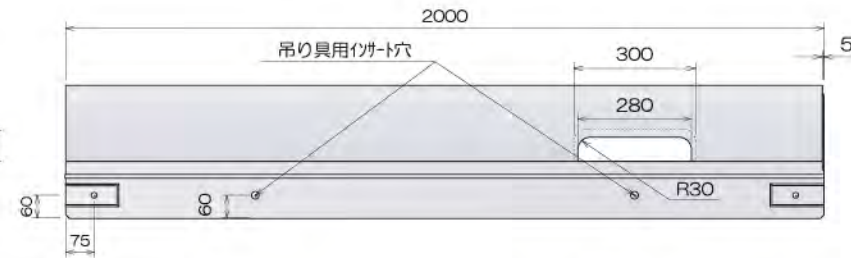
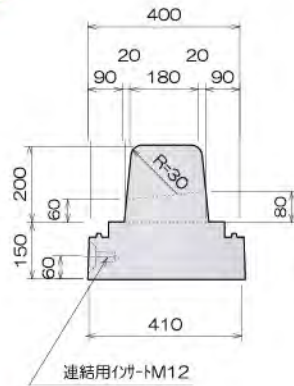

参考重量 461kg

## 切下げ

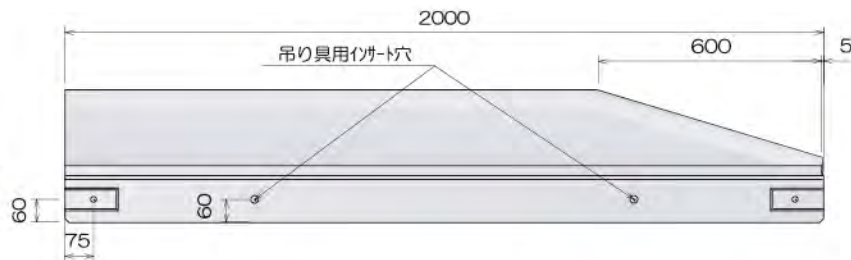
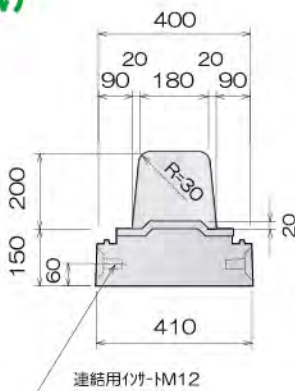

参考重量 434kg

## 草止 切り欠部詳細

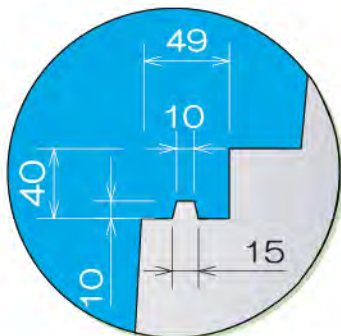

## 連結部詳細

